

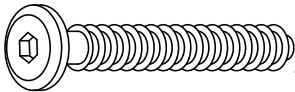



A	 7 50 mm	10	B		01
---	--	----	---	--	----

01

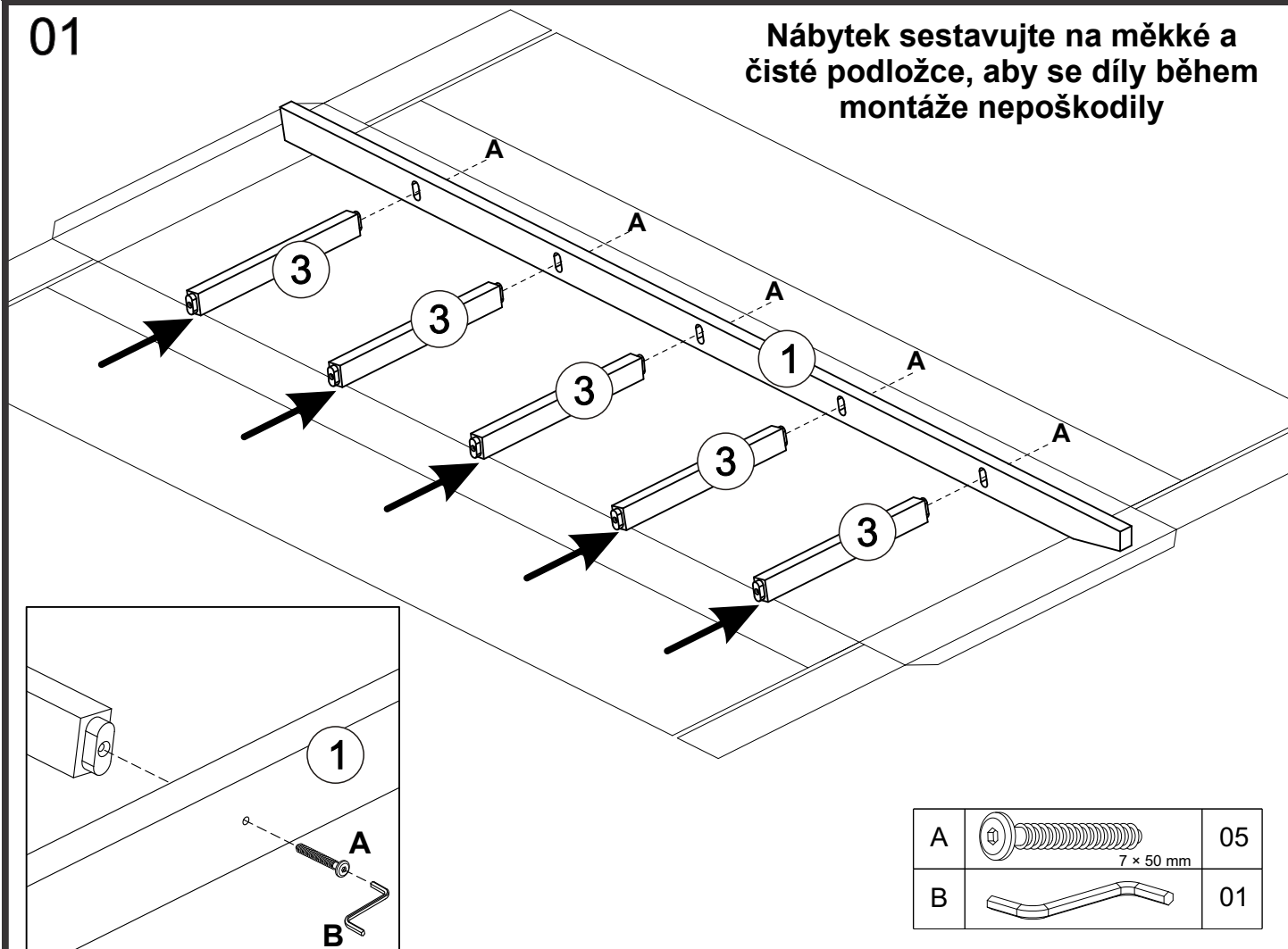

Nábytek sestavujte na měkké a  
čisté podložce, aby se díly během  
montáže nepoškodily

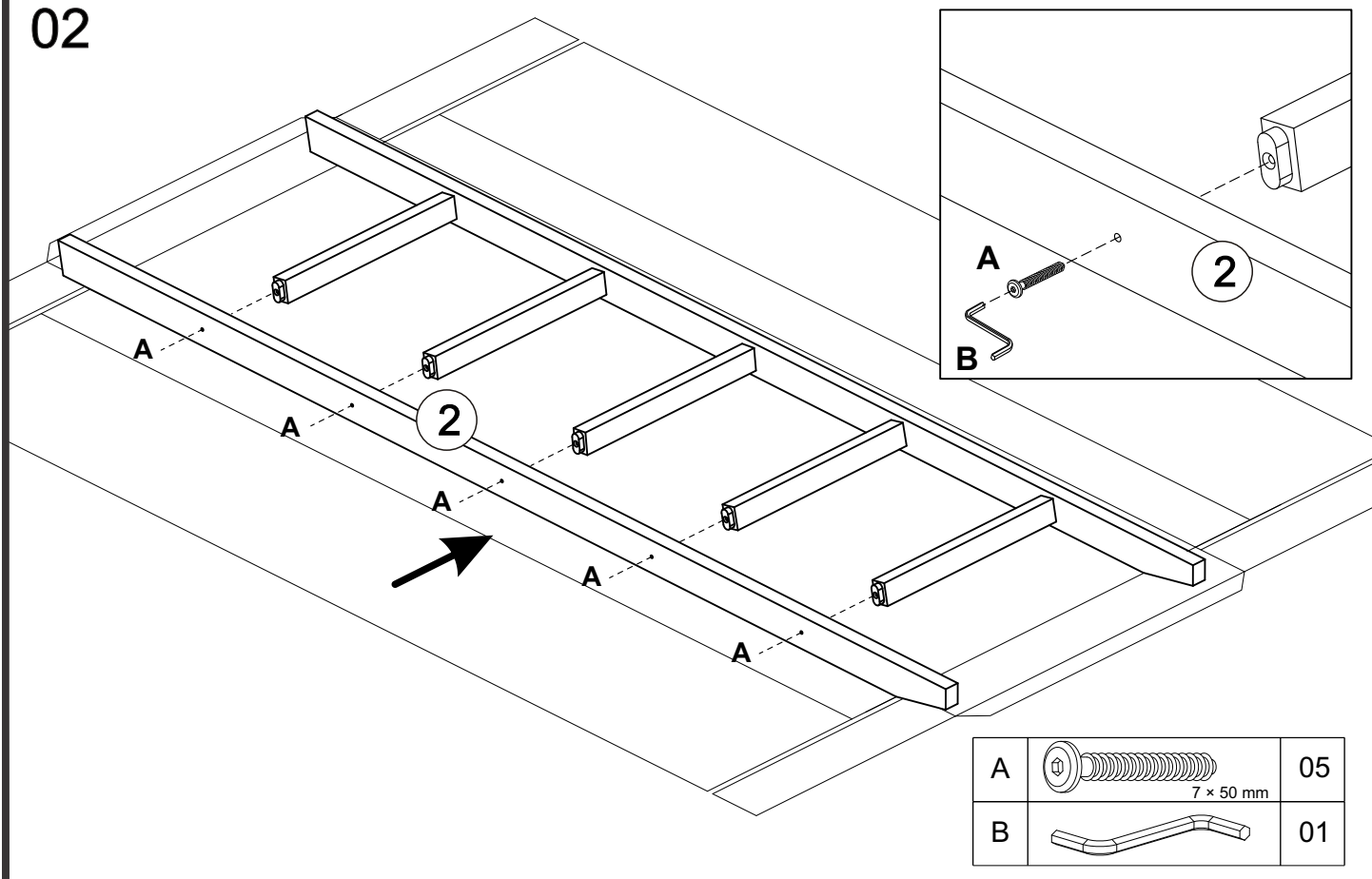

A	 7 x 50 mm	05
B		01

02

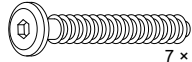

A	 7 x 50 mm	05
B		01