

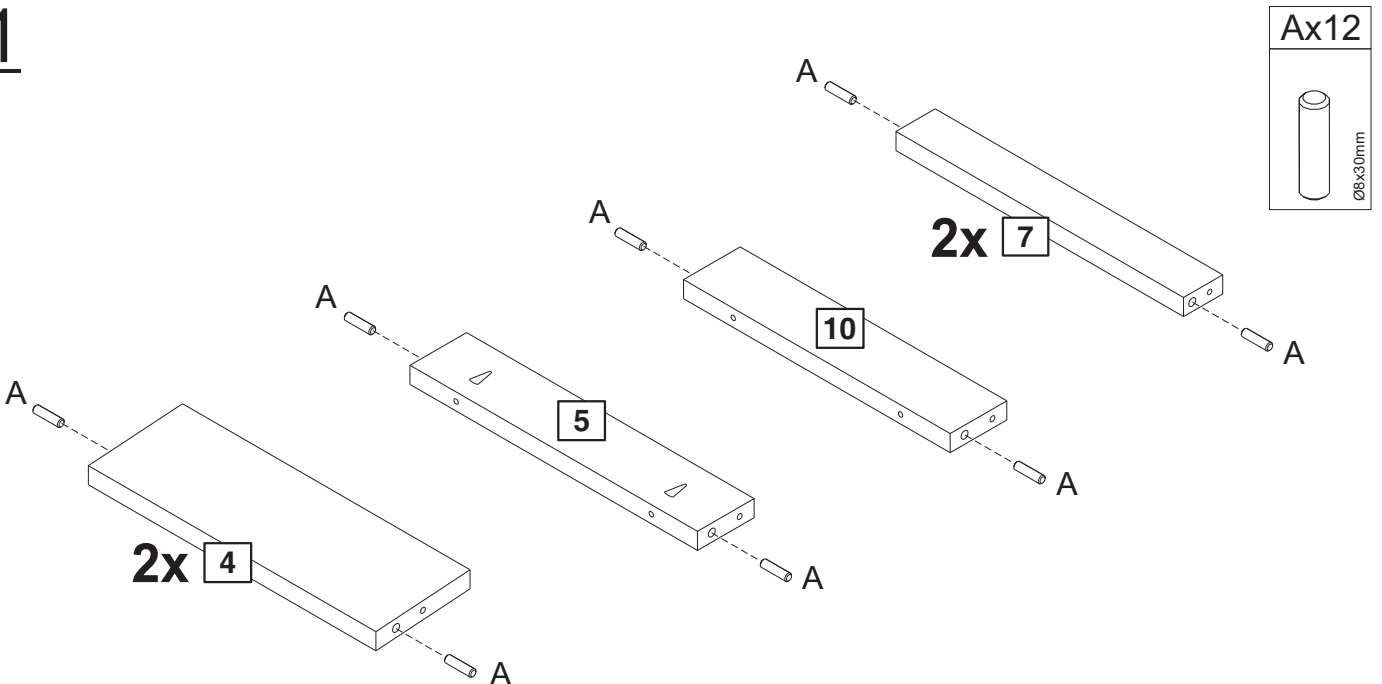

1

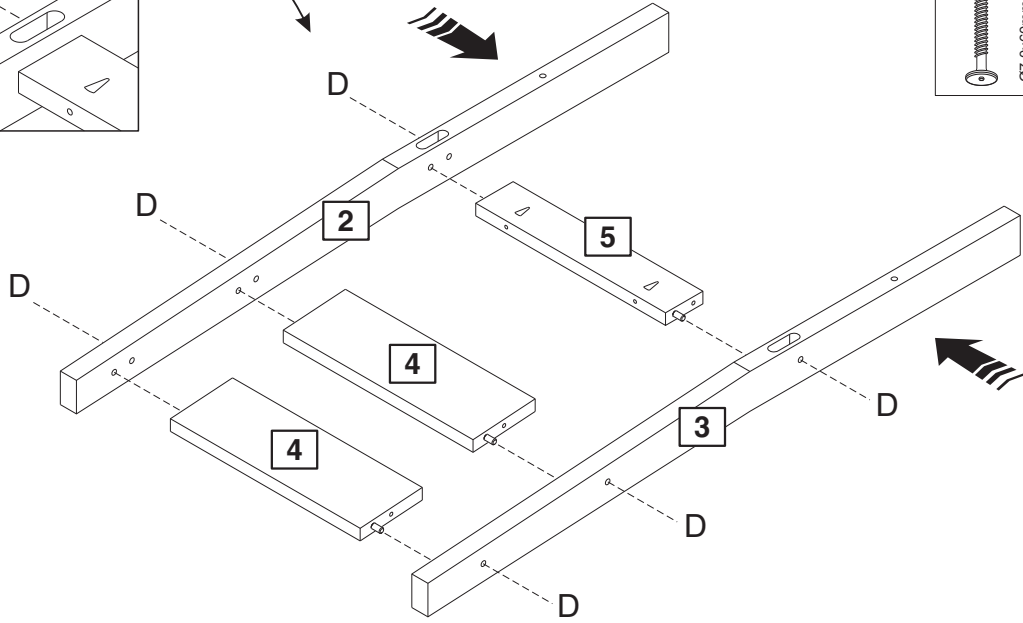

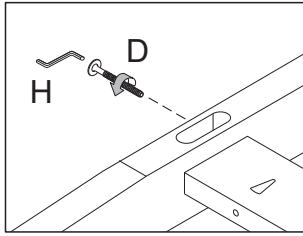

2



Dx6	Hx1
	
$\text{Ø}7,0 \times 60\text{mm}$	

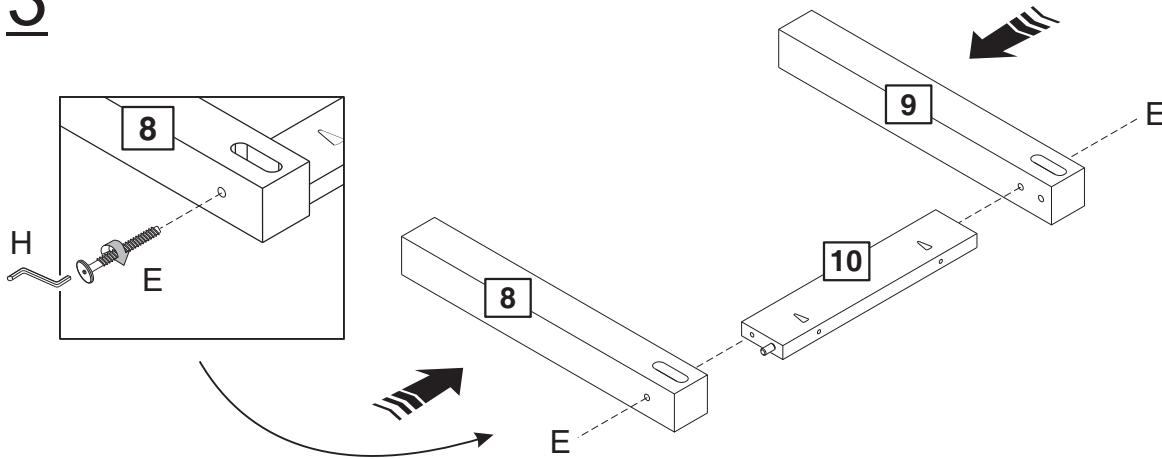
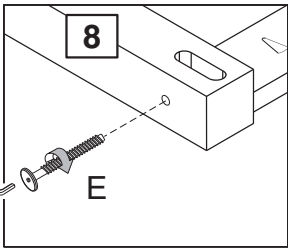



3

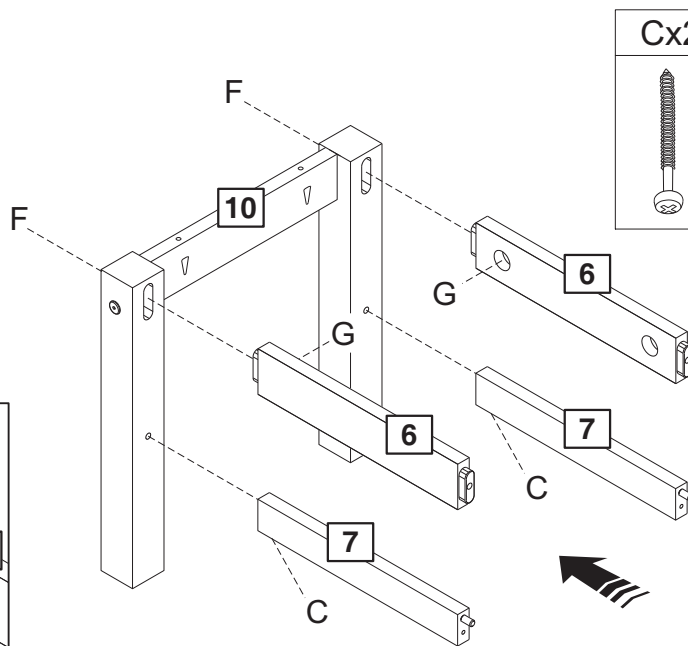
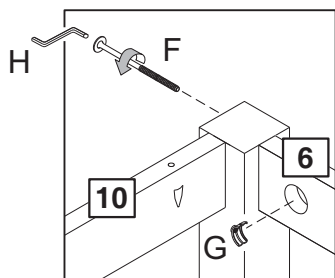

Ex2	Hx1
	
$\text{Ø}7,0 \times 80\text{mm}$	



4

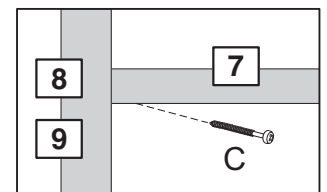

Cx2	Fx2	Gx2	Hx1
			
$\text{Ø}4,5 \times 50\text{mm}$	$\text{Ø}1,4 \times 130\text{mm}$		

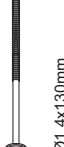

5

Cx2	Fx2	Gx2	Hx1
 Ø4,5x50mm	 Ø1,4x130mm		

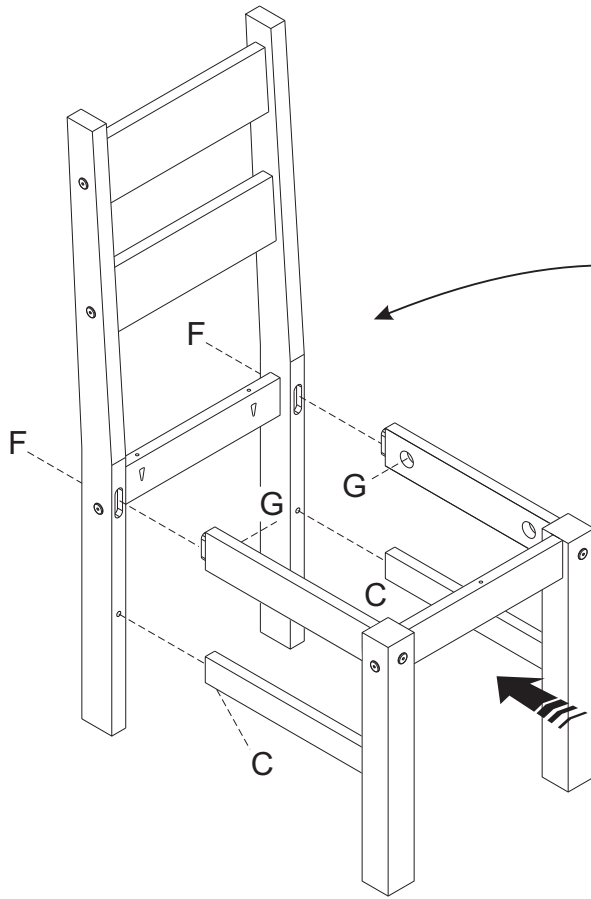

a:

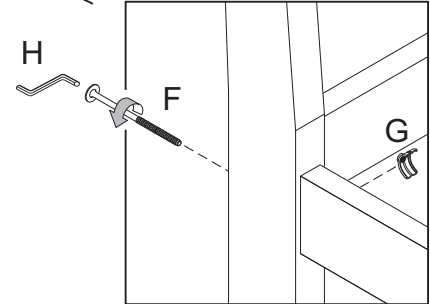

b:

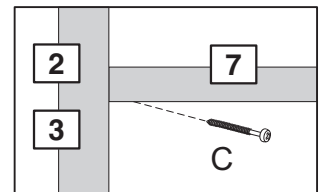

6

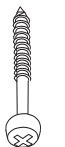
Bx4
 Ø4,0x35mm

